



*net*sys

Networking your world

NS-280FX

8x SFP Slots with 2 Giga unmanaged Ethernet switch

USER'S MANUAL

NS-280FX: 8x SFP Slots with 2 Giga unmanaged Ethernet switch Ver.A.5

Copyright

Copyright © 2020 by National Enhance Technology Corp. All rights reserved.

Trademarks

NETSYS is a trademark of National Enhance Technology Corp.

Other brand and product names are registered trademarks or trademarks of their respective holders.

Legal Disclaimer

The information given in this document shall in no event be regarded as a guarantee of conditions or characteristics. With respect to any examples or hints given herein, any typical values stated herein and/or any information regarding the application of the device, National Enhance Technology Corp. hereby disclaims any and all warranties and liabilities of any kind, including without limitation warranties of non-infringement of intellectual property rights of any third party.

Statement of Conditions

In the interest of improving internal design, operational function, and/or reliability, NETSYS reserves the right to make changes to the products described in this document without notice. NETSYS does not assume any liability that may occur due to the use or application of the product(s) or circuit layout(s) described herein.

Maximum signal rate derived from IEEE Standard specifications. Actual data throughput will vary. Network conditions and environmental factors, including volume of network traffic, building materials and construction, and network overhead, lower actual data throughput rate. Netsys does not warrant that the hardware will work properly in all environments and applications, and makes no warranty and representation, either implied or expressed, with respect to the quality, performance, merchantability, or fitness for a particular purpose. Make sure you follow in line with the environmental conditions to use this product.

NS-280FX: 8x SFP Slots with 2 Giga unmanaged Ethernet switch Ver.A.5

Foreword

NS-280FX is an unmanaged SFP switch, each SFP port especial designed support high power source for feeding high power consumption SFP module as VDSL2-SFP / G.fast-SFP module, if install them it can be became a unmanaged IP DSLAM, or mixing install VDSL2-SFP / G.fast-SFP module plus Fiber optical module to extend your networking services and applications to farther places. NS-280FX also supports isolation function on SFP port for security, which can be easily configured by slide switch on front panel. There are lots of Multi-ple ports SFP switches in the market always power source is not enough to driver VDSL2-SFP / G.fast module or encounter overheat issue. Therefore, Netsys company put lots of effort for power source and good heat dissipation as NS-280FX's SFP slots are separated to each other, and build in two internal fans to prevent SFP module overheat issue. With high performance and easy installation, NS-280FX can be utilized in ISP network solution for FTTdp(Fiber to the distribution point), FTTC (Fiber to the Curb) and FTTB (Fiber to the Building), also for SOHO application.

Attention:

Be sure to read this manual carefully before using this product. Especially Legal Disclaimer, Statement of Conditions and Safety Warnings.

Caution:

The **NS-280FX** is for **indoor** applications only. This product does not have waterproof protection. Do not use in harsh environments (Over temperature range: 0°C ~ 50°C (32°F ~ 122°F)).

NS-280FX: 8x SFP Slots with 2 Giga unmanaged Ethernet switch Ver.A.5

Safety Warnings

For your safety, be sure to read and follow all warning notices and instructions before using the device.

- ◆ **DO NOT** open the device or unit. Opening or removing covers can expose you to dangerous high voltage points or other risks. ONLY qualified service personnel can service the device. Please contact your vendor for further information.
- ◆ **Use ONLY** the dedicated power supply for your device. Connect the power cord to the right supply voltage (110V AC used for North America and 230V AC used for Europe).
- ◆ **DO NOT** use the device if the power supply is damaged as it might cause electrocution. If the power supply is damaged, remove it from the power outlet. **DO NOT** attempt to repair the power supply. Contact your local vendor to order a new power supply.
- ◆ **Place** connecting cables carefully so that no one will step on them or stumble over them. **DO NOT** allow anything to rest on the power cord and do not locate the product where anyone can work on the power cord.
- ◆ **DO NOT** install nor use your device during a thunderstorm. There may be a remote risk of electric shock from lightning.
- ◆ **DO NOT** expose your device to dampness, dust or corrosive liquids.
- ◆ **DO NOT** use this product near water, for example, in a wet basement or near a swimming pool.
- ◆ **Connect ONLY** suitable accessories to the device. Make sure to connect the cables to the correct ports.
- ◆ **DO NOT** obstruct the device ventilation slots, as insufficient airflow may harm your device.
- ◆ **DO NOT** place items on the device.
- ◆ **DO NOT** use the device for outdoor applications, and make sure all the connections are indoors. There may be a remote risk of electric shock from lightning.
- ◆ **Be careful** when unplugging the power, because the transformer may be very hot.
- ◆ **Keep** the device and all its parts and accessories out of children's reach.

NS-280FX: 8x SFP Slots with 2 Giga unmanaged Ethernet switch Ver.A.5

- ◆ **Clean** the device using a soft and dry cloth rather than liquid or atomizers. Power off the equipment before cleansing it.
- ◆ This product is **recyclable**. Dispose of it properly.

Table of Contents

| | |
|--|-----------|
| Copyright | 2 |
| Foreword | 3 |
| Safety Warnings | 4 |
| Chapter 1. Unpacking Information | 7 |
| 1.1 Check List..... | 7 |
| Chapter 2. Installing the Device | 8 |
| 2.1 Hardware Installation | 8 |
| 2.2 Pre-installation Requirements | 8 |
| 2.3 Connecting the Ethernet of RJ-45 Ports | 9 |
| 2.4 Connecting the SFP Slot..... | 9 |
| 2.5 Application Diagram..... | 10 |
| Chapter 3. Hardware Description | 11 |
| 3.1 Front panel..... | 11 |
| 3.2 LED Indicators | 13 |
| Appendix A: Cable Requirements | 14 |

NS-280FX: 8x SFP Slots with 2 Giga unmanaged Ethernet switch Ver.A.5

| | |
|--|----|
| Appendix B: Product Specification | 16 |
| Appendix C: Mounting the Switch on a Rack..... | 18 |
| Appendix D: Troubleshooting | 19 |
| Appendix E: Compliance and Safety Information | 22 |
| Warranty | 25 |
| Chinese SJ/T 11364-2014..... | 26 |



NS-280FX: 8x SFP Slots with 2 Giga unmanaged Ethernet switch Ver.A.5

Chapter 1. Unpacking Information

1.1 Check List

Carefully unpack the package and check its contents against the check list.

Package Contents:

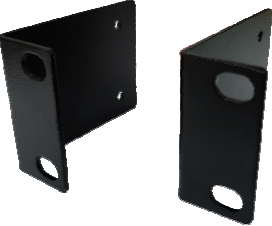
| | | | |
|---|--|---|---|
|  |  |  |  |
| 1 x NS-280FX | 1 x QR code for user's manual hyperlink. | Accessory: 1 x AC Power Cord, 2 X Rack mount bracket (Optional) , 8 x SFP cover | |

Notes:

1. Please inform your dealer immediately for any missing or damaged parts. If possible, retain the carton including the original packing materials. Use them to repack the unit in case there is a need to return for repair.
2. If the product has any issue, please contact your local vendor.
3. Please make sure power source is compliant with required specification.
4. NS-280FX is a commercial-grade product. Do not use in industrial-grade applications.
5. Please look for the QR code on the bottom of the product, the user can launch the QR code scanning program to scan and download the user's manual electronic format file. Above QR code icon is for reference.

Chapter 2. Installing the Device

2.1 Hardware Installation

This chapter describes how to install the device and establish the network connections. The NS-280FX may be installed on any level surface (e.g. a table or shelf, 19 inch rack or wall mounting). However, please take note of the following minimum site requirements before one begin.

- ◆ 4 plastic feet on the bottom has been pre-installed.

2.2 Pre-installation Requirements

Before you start the actual hardware installation, make sure you can provide the right operating environment, including power requirements, sufficient physical space, and proximity to other network devices that are to be connected.

Verify the following installation requirements:

- Power requirements: **AC 100-240 volts / 50-60 Hz**
- The device should be located in a cool dry place, with at least **10cm/4in** of space at the front and back for ventilation.
- Place NS-280FX away from direct sunlight, heat sources, or areas with a high amount of electromagnetic interference.
- Check if the network cables and connectors needed for installation are available.
- Do not install phone lines strapped together with AC power lines, or telephone office line with voice signal.
- Avoid installing this device with radio amplifying station nearby or transformer station nearby.

NS-280FX: 8x SFP Slots with 2 Giga unmanaged Ethernet switch Ver.A.5

2.3 Connecting the Ethernet of RJ-45 Ports

NS-280FX has two Ethernet ports which support connection to Ethernet operation. The devices attached to these ports must support auto-negotiation or 10Base-T, 100Base-T or 1000Base-T, and note they don't support half duplex. Use any of the Ethernet ports to connect to devices such as Monitor system, Server, Backbone switch, or IP gateway.

2.4 Connecting the SFP Slot

There are multiple types of SFP module in market, please make sure the SFP module support 1000X/SerDes mode; otherwise, the connection can't set up any more.

NS-280FX: 8x SFP Slots with 2 Giga unmanaged Ethernet switch Ver.A.5

2.5 Application Diagram

NS-280FX is an ideal solution for FTTC/FTTB, MDU usage and SOHO application. NS-280FX can either be used as an upstream internet provider or a downstream internet receiver in your Network system, which makes NS-280FX meet user's requirement, and offer you a variety of combination with other networking devices.

With 8 SFP slots and suitable SFP transceiver, NS-280FX is able to be considered as an IPDSLAM, and would perfectly fit in Fiber / XDSL networking system. NS-280FX also enable user to segment their SFP network, and set up multiple isolated network at your premises, such as your home, office, school, etc. (Figure 2.5.1)

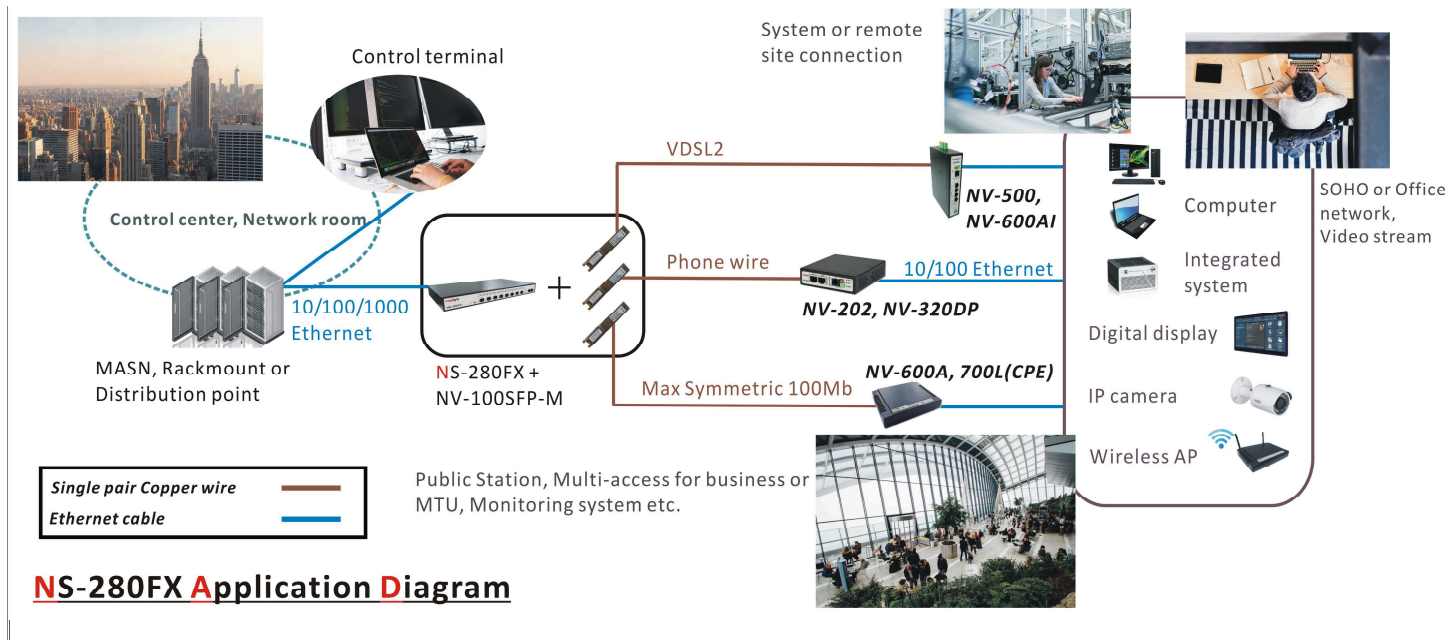

Figure 2.5.1 Application Diagram

NS-280FX: 8x SFP Slots with 2 Giga unmanaged Ethernet switch Ver.A.5

Chapter 3. Hardware Description

This section describes the important parts of NS-280FX. It features the front panel and rear panel.

3.1 Front Panel:

The front panel shown as interface with 8 x SFP Slots, 2 x RJ-45 Connector, Slide switch for Isolation function and LED indicators.

3.1.1 Front panel indicator:

There are 16 LED indicators on front panel, the following Table shows the description.

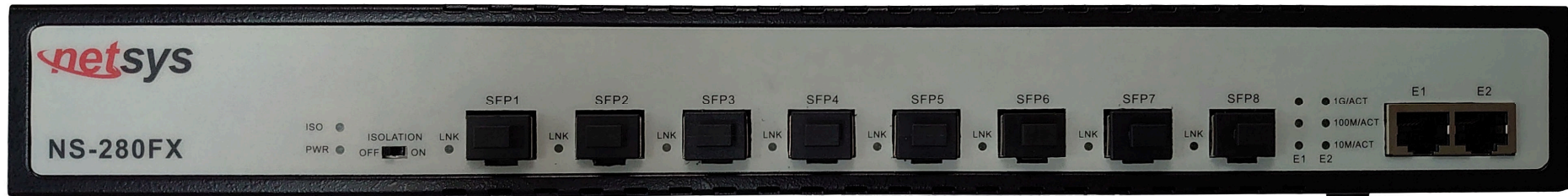

Figure 3.1 Front Panel

Tip: With only a glance of the front panel's LED indicators, the converter status will be fully aware.

NS-280FX: 8x SFP Slots with 2 Giga unmanaged Ethernet switch Ver.A.5

Table 3-1 Description of the front interface

| Port Name | Interface Type | Description |
|-----------|-----------------|---|
| E1 / E2 | RJ-45 connector | For connecting to a Backbone or IP gateway networking device. |
| SFP | SFP slot | For small form-factor pluggable transceiver. |
| Isolation | Slide switch | For enabling / disabling SFP port Isolation function. |

Reminder:

Please use SFP transceiver which is compatible to 1000Base-X SFP slot, otherwise, the connection cannot set up.

3.1.2 Slide switch

For setting SFP port isolation mode. To activate isolation function, slide the switch to ON.

3.1.3 Rear Panel

The rear panel provides AC Power Jack and two built-in internal fans.



Figure 3.1.3 Rear Panel

NS-280FX: 8x SFP Slots with 2 Giga unmanaged Ethernet switch Ver.A.5

3.2 LED Indicators

The NS-280FX has 16 LED indicators. The following Table shows the description. (Table 3-2)

Table 3-2 LED Indicators Description and Operation

| LEDs | Color | Status | Description |
|---|-------|-------------|--|
| PWR | Green | ON | Power ON |
| | | OFF | Power OFF |
| E1/E2(Ethernet) LNK/ACT (10M/100M/1G) | Green | ON (Steady) | 10/100/1G Ethernet Link established |
| | | Blinking | The device is sending or receiving data. |
| | | OFF | No Connection |
| ISO(Isolation) | Green | ON | SFP slots Isolation mode |
| | | OFF | SFP slots Un-Isolation mode |
| SFP1-SFP8 | Green | ON | Link established |
| | | OFF | No connection |

Remark: 1. Except for Fiber SFP transceiver, SFP LED indicator will light up right away when the SFP transceiver is inserted into SFP slot.

NS-280FX: 8x SFP Slots with 2 Giga unmanaged Ethernet switch Ver.A.5

Appendix A: Cable Requirements

A.1 Ethernet Cable

A CAT 5~7 UTP (unshielded twisted pair) cable is typically used to connect the Ethernet device to the Modem. A: 10/100TX cable often consists of four pairs of wires, two of which are used for transmission. The connector at the end of the 10/100TX cable is referred to as a RJ-45 connector and it consists of eight pins. The Ethernet standard uses pins 1, 2, 3 and 6 for data transmission purposes. (Table A-1 10/100TX)

B: 1000TX cable often consists of four pairs of wires, all of which are used for transmission. The connector at the end of the 1000TX cable is referred to as a RJ-45 connector and it consists of eight pins. The Ethernet standard uses pins 1, 2, 3, 4, 5 and 6 for data transmission purposes. (Table A-1 1000TX)

Table A-1 RJ-45 Ethernet Connector Pin Assignments

| PIN # | 10/100TX | | 1000TX | |
|-------|----------|---------------------------|--------|---------------------------------|
| | Signal | Media Dependant interface | Signal | Media Dependant interface-cross |
| 1 | TX+ | Transmit Data+ | BI_DA+ | Bi-directional pair A+ |
| 2 | TX- | Transmit Data- | BI_DA- | Bi-directional pair A- |
| 3 | RX+ | Receive Data+ | BI_DB+ | Bi-directional pair B+ |
| 4 | NC | Unused | BI_DC+ | Bi-directional pair C+ |
| 5 | NC | Unused- | BI_DC- | Bi-directional pair C- |
| 6 | RX- | Receive Data- | BI_DB- | Bi-directional pair B- |
| 7 | NC | Unused | BI_DD+ | Bi-directional pair D+ |
| 8 | NC | Unused | BI_DD- | Bi-directional pair D- |

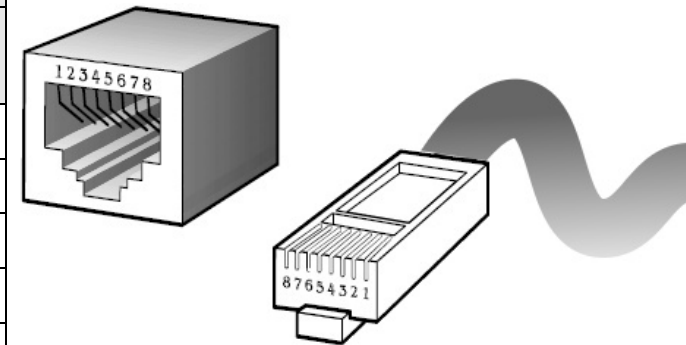

Figure A-1 Standard RJ-45 receptacle/connector

NS-280FX: 8x SFP Slots with 2 Giga unmanaged Ethernet switch Ver.A.5

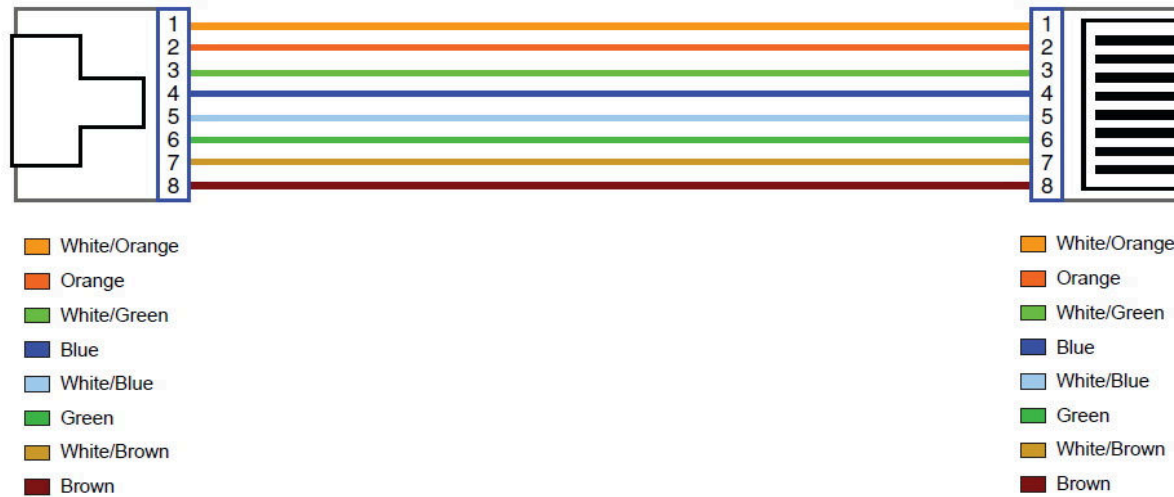

Figure A-2 Pin Assignments and Wiring for an RJ-45 Straight-Through Cable

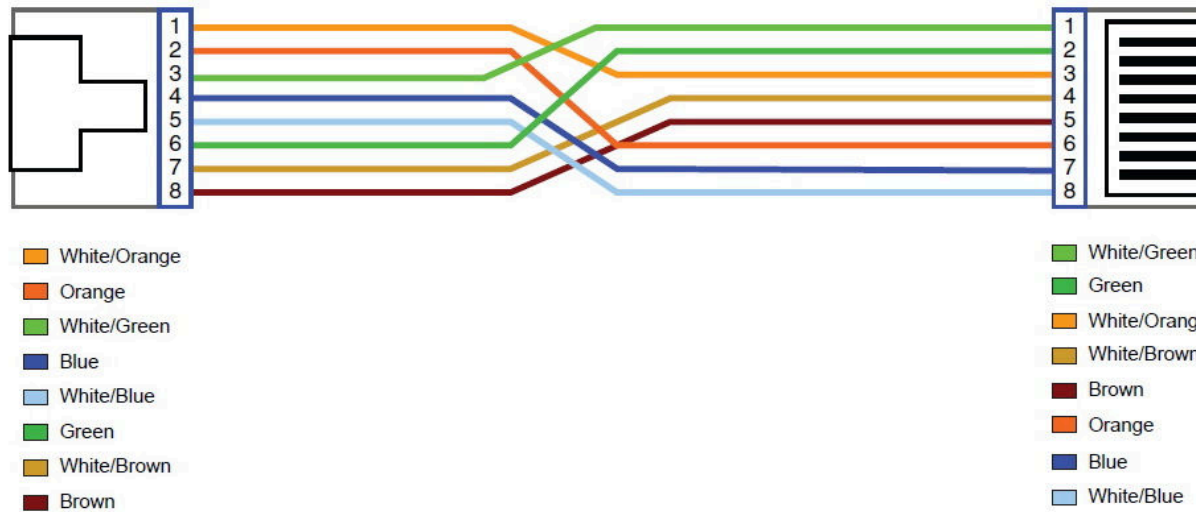

Figure A-3 Pin Assignments and Wiring for an RJ-45 Crossover Cable

Appendix B: Product Specification

Key Features and Benefits:

- ◆ Supports 2 x 10/100/1000BASE-T & auto-MDIX for RJ-45 port
- ◆ Supports 8 x 1.25G SFP Slots
- ◆ Cost effective bridge function for FTTdp/FTTC application
- ◆ Compatible to VDSL2 SFP module
- ◆ Support per SFP slot power source up to 3W
- ◆ Special design for VDSL2/G.fast-SFP module heat dissipation
- ◆ Supports isolation mode by Slide switch
- ◆ Compact in size, easy installation
- ◆ Plug & Play
- ◆ Flexible application & installation
- ◆ Support MTU 1632 bytes
- ◆ Supports 19" Rack mount bracket (Optional)

NS-280FX: 8x SFP Slots with 2 Giga unmanaged Ethernet switch Ver.A.5

Specification:

| Item | Description |
|---------------------------------|---|
| Protocol and Standards : | IEEE 802.3u / IEEE802.3ab / IEEE802.3z |
| Cabling requirements: | Ethernet: 10/100/1000Base-T Cat.5 or above UTP Cable Fiber Optic: 1000Base-X Flexible (Depending on Fiber Transceiver) |
| Modes : | SFP ports Isolation function |
| Interface : | 2 x RJ-45 10/100/1000Mbps auto-negotiation Ethernet port 、 8 x 1000X/SerDes SFP slot 、 1 x slide switch |
| LED Indication : | SYSTEM : PWR (Power LED) ISOLATION MODE : ISO Giga PORT : 1G/ ACT,100M/ACT,10M/ACT SFP PORT : LNK (Link LED) |
| Certification : | CE, FCC, RoHS Compliant |
| Temperature : | 0°C ~ 50°C (32°F ~ 122°F) (Operating) -20°C ~ 70°C (-4°F ~ 158°F) (Storage) |
| Optional accessories : | Rack mount bracket |
| Humidity : | 10 - 90% (non-condensing) |
| Weight : | 1.645 kg |
| Dimensions : | 356mm x 156mm x 44mm (14" x 6.14" x 1.73") |
| Power Consumption : | 4W(Empty load) |
| Power Supply | Input : AC 100~240 volts/50~60Hz |

NS-280FX: 8x SFP Slots with 2 Giga unmanaged Ethernet switch Ver.A.5

Appendix C: Mounting the Switch on a Rack

1. Position a mounting bracket on one side of the rack, lining up the two screw holes on the bracket with the screw holes on the side of the rack as figure below.
2. Using a screwdriver, install the M5 flat head screws through the mounting bracket holes into the rack.
3. Repeat steps 1 and 2 to attach the second mounting bracket on the other side of the rack.



Appendix D: Troubleshooting

Diagnosing Switch's Indicators

The Bridge can be easily monitored through its comprehensive panel indicators. These indicators assist in identifying problems the Media Converter may encounter. This section describes common problems you may encounter and possible solutions:

| | |
|--------------------|---|
| 1. Symptom: | POWER indicator does not light up (green) after power on. |
| Cause: | Defective power source or power supply. |
| Solution: | Check the power source by using another power cord that is functioning properly. Check the power cord with another device. If these measures fail to resolve the problem, have the unit sent back to a qualified distributor. |
| 2. Symptom: | Link indicator does not light up (green) after making a connection. |
| Cause: | Network interface (ex. a network adapter card on the attached device), network cable, or SFP transceiver defective. |
| Solution: | <ul style="list-style-type: none">◆ Verify if both of the NS-280FX (all devices) and attached device are powered on.◆ Be sure the Ethernet cable and fiber optics are plugged into both the switch and corresponding device.◆ Verify that the proper cable type is used and its length does not exceed specified limits.◆ Check the cable connections for possible defects.◆ Replace the defective cable if necessary.◆ Please make sure SFP transceiver support 1.25G Serdes mode |

NS-280FX: 8x SFP Slots with 2 Giga unmanaged Ethernet switch Ver.A.5

| | |
|--------------------|---|
| 3. Symptom: | RJ-45 port link LED light up without transmission . |
| Cause: | RJ-45 port link on half duplex mode or LED jitter happen |
| Solution: | Please make sure opposite side device setting on full duplex mode, since NS-280FX doesn't support half duplex mode. If LED jitter it mean both internal chipset without compatible. |

Power and Cooling Problems

If the POWER indicator does not turn on when the power cord is plugged in, you may have a problem with the power outlet, power cord, or internal power supply. However, if the unit power is off after running for a while, check for loose power connections, power losses or surges at the power outlet. If you still cannot isolate the problem, then the internal power supply may be defective. In this case, please contact your local dealer.

Installation

Verify that all system components have been properly installed. If one or more components appear to be malfunctioning (e.g. the power cord or network cabling), test them in an alternate environment where you are sure that all the other components are functioning properly.

Transmission Mode

The default of transmission mode for RJ-45 ports is 10/100/1000 Mbps Ethernet, SFP port is 1.25Gbps (1000Base-X). Therefore, if the Link signal is disrupted (e.g. by unplugging the network cable and plugging it back in again, or by resetting the power), the port will try to re-establish connection with the attached device via auto-negotiation.

Physical Configuration

If problems occur after altering the network configuration, restore the original connections, and try to track the problem

NS-280FX: 8x SFP Slots with 2 Giga unmanaged Ethernet switch Ver.A.5

down by implementing the new changes, one step at a time. Ensure that cable distances and other physical aspects of the installation do not exceed recommendations.

System Integrity

As a last resort verify the switch integrity with a power-on reset. Turn the power to the switch off and then on several times. If the problem still persists and you have completed all the preceding diagnoses, then contact your dealer.

Appendix E: Compliance and Safety Information

FCC Radio Frequency Interference Statement

This equipment has been tested and found to comply with the limits for a computing device, pursuant to Part 15 of FCC class A rules. These limits are designed to provide reasonable protection against harmful interference when the equipment is operated in a commercial environment. This equipment generate, uses and can radiate radio frequency energy and, if not installed and used in accordance with the instructions, may cause harmful interference to radio communications. However, there is no guarantee that interference will not occur in a particular installation. If this equipment does cause harmful interference to radio or television reception, which can be determined by turning the equipment off and on, the user is encouraged to try to correct the interference by one or more of the following measures:

1. Reorient or relocate the receiving antenna.
2. Increase the separation between the equipment and receiver.
3. The equipment and the receiver should be connected to outlets on separate circuits.
4. Consult the dealer or an experienced radio/television technician for help.

Changes or modifications not expressly approved by the party responsible for compliance could void the user's authority to operate the equipment.

If this telephone equipment causes harm to the telephone network, the telephone company will notify you in advance that temporary discontinuance of service may be required. But if advance notice isn't practical, the telephone company will notify the customer as soon as possible. Also, you will be advised of your right to file a complaint with the FCC if you believe it is necessary.

The telephone company may make changes in its facilities, equipment, operations or procedures that could affect the

NS-280FX: 8x SFP Slots with 2 Giga unmanaged Ethernet switch Ver.A.5

proper functioning of your equipment. If they do, you will be notified in advance in order for you to make necessary modifications to maintain uninterrupted service.

This equipment may not be used on coin service provided by the telephone company. Connection to party lines is subject to state tariffs.

Important Safety Instructions

- ◆ **Caution:** The direct plug-in wall transformer serves as the main product for disconnecting. The socket outlet shall be installed near the product and be readily accessible.
- ◆ **Do not** use this equipment near water, for example in a wet basement.
- ◆ **Avoid** using a telephone during an electrical storm. There may be a remote risk of electrical shock from lightning.
- ◆ **Do not** use the telephone to report a gas leak in the vicinity of the leaking area.
- ◆ If you experience trouble with this unit, please contact customer service of your dealer immediately.
- ◆ **DO NOT DISASSEMBLE THIS EQUIPMENT.** It does not contain any user serviceable components.

NS-280FX: 8x SFP Slots with 2 Giga unmanaged Ethernet switch Ver.A.5

FCC Warning



This equipment has been tested to comply with the limits for a Class A digital device, pursuant to Part 15 of the FCC Rules. These limits are designed to provide reasonable protection against harmful interference when the equipment is operated in a commercial environment. This equipment can generate, use, and radiate radio frequency energy and, if not installed and used in accordance with the instruction manual, may cause harmful interference to radio communications. Operation of this equipment in a residential area is likely to cause harmful interference in which case the user will be required to correct the interference at owner's expense.

CE Mark Warning



This is a class A product. In a domestic environment, this product may cause radio interference in which case the user may be required to take adequate measures.

RoHS Mark Warning



RoHS stands for Restriction of Hazardous Substances, and impacts the entire electronics industry and many electrical products as well. The original RoHS, also known as Directive 2002/95/EC, originated in the European Union in

NS-280FX: 8x SFP Slots with 2 Giga unmanaged Ethernet switch Ver.A.5

2002 and restricts the use of six hazardous materials found in electrical and electronic products. All applicable products in the EU market since July 1, 2006 must pass RoHS compliance. Directive 2011/65/EU was published in 2011 by the EU, which is known as RoHS-Recast or RoHS 2. RoHS 2 includes a **CE-marking directive**, with RoHS compliance now being required for CE marking of products. RoHS 2 also added Categories 8 and 9, and has additional compliance recordkeeping requirements. Directive 2015/863 was published in 2015 by the EU, which is known as RoHS 3. RoHS 3 adds four additional restricted substances (phthalates) to the list of six.

WEEE Warning



To avoid the potential effects on the environment and human health as a result of the presence of hazardous substances in electrical and electronic equipment, end users of electrical and electronic equipment should understand the meaning of the crossed-out wheeled bin symbol. Do not dispose of WEEE as unsorted municipal waste and have to collect such WEEE separately.

Warranty

The original owner that the product delivered in this package will be free from defects in material and workmanship for one year parts after purchase.

There will be a minimal charge to replace consumable components, such as fuses, power transformers, and mechanical cooling devices. The warranty will not apply to any products which have been subjected to any misuse, neglect or accidental damage, or which contain defects which are in any way attributable to improper installation or to alteration or repairs made or performed by any person not under control of the original owner.

NS-280FX: 8x SFP Slots with 2 Giga unmanaged Ethernet switch Ver.A.5

The above warranty is in lieu of any other warranty, whether express, implied, or statutory, including but not limited to any warranty of merchantability, fitness for a particular purpose, or any warranty arising out of any proposal, specification, or sample. We shall not be liable for incidental or consequential damages. We neither assume nor authorize any person to assume for it any other liability.

WARNING
Warranty Void
If Removed

WARNING:

- 1. DO NOT TEAR OFF OR REMOVE THE WARRANTY STICKER AS SHOWN, OR THE WARRANTY IS VOID.**
- 2. WARRANTY VOID IF USE COMMERCIAL-GRADE POWER SUPPLY IS USED AT HARSH ENVIRONMENTS.**

Chinese SJ/T 11364-2014

| 部件名称 | 有毒有害物质或元素 | | | | | |
|-------|-----------|-------|-------|-------------|-----------|-------------|
| | 铅(Pb) | 汞(Hg) | 镉(Cd) | 六价铬[Cr(VI)] | 多溴联苯(PBB) | 多溴二苯醚(PBDE) |
| 结构壳体 | ○ | ○ | ○ | ○ | ○ | ○ |
| 电路组 | ○ | ○ | ○ | ○ | ○ | ○ |
| 电源供应器 | ○ | ○ | ○ | ○ | ○ | ○ |
| 线材 | ○ | ○ | ○ | ○ | ○ | ○ |
| 包装及配件 | ○ | ○ | ○ | ○ | ○ | ○ |

表示该有毒物质在该部件所有均质材料中的含量均在：○GB/T 26572。标准规定的限量要求以下
表示该有毒物质至少在该部件的某均质材料中的含量超出：×GB/T 26572。定的限量要求标准规

上述规范仅适用于中国法律